



PAXTON

SUPERCHARGERS



Owner's Installation Guide for the
***Paxton Automotive
Novi 2000 Supercharger***
for the
1985 5.0L Ford Mustang

**Paxton Automotive . 1300 Beacon Place . Oxnard CA 93033
805 604-1336 . FAX (805) 604-1337**

FOREWORD

This manual provides information on the installation, maintenance and service of the Paxton supercharger kit expressly designed for the 1985 5.0 Ford Mustang Contact Paxton Automotive Corporation for any additional information regarding this kit and any of these modifications at (805) 604-1336 8:00am-4:30pm PST.

An understanding of the information contained herein will help novices, as well as experienced technicians, to correctly install and receive the greatest possible benefit from their Paxton supercharger. When reference is made in this manual to a brand name, number, specific tool or technique, an equivalent product may be used in place of the item mentioned. All information, illustrations and specifications contained herein are based on the latest product information available at the time of this publication. All rights reserved to make changes at any time without notice.

© **2006 PAXTON AUTOMOTIVE**

All rights reserved. No part of this publication may be reproduced, transmitted, transcribed, or translated into another language in any form, by any means without written permission of Paxton Automotive.

TABLE OF CONTENTS

FOREWORD	<i>ii</i>
TABLE OF CONTENTS	<i>iii</i>
IMPORTANT NOTE	<i>iv</i>
TOOL & SUPPLY REQUIREMENTS	<i>v</i>
PARTS LIST (<i>1985 Ford 5.0L Mustang</i>)	<i>vii</i>
1. PREPARATION AND REMOVAL	1-1
1.1 PREPARATION AND REMOVAL	1-1
2. SUPERCHARGER OIL DRAIN AND OIL FEED ASSEMBLY	2-1
2.1 SUPERCHARGER OIL FEED ASSEMBLY	2-1
2.2 SUPERCHARGER OIL DRAIN ASSEMBLY	2-1
3. SUPERCHARGER BRACKET ASSEMBLY AND MOUNTING	3-1
3.1 SUPERCHARGER BRACKET ASSEMBLY	3-1
3.2 CRANK PULLEY ASSEMBLY	3-1
4. FUEL PUMP REPLACEMENT	4-1
4.1 FUEL PUMP REPLACEMENT	4-1
5. CARBURETOR ENCLOSURE INSTALLATION	5-1
5.1 CARBURETOR ENCLOSURE INSTALLATION	5-1
5.2 THROTTLE CABLE INSTALLATION	5-3
6. AIR INLET INSTALLATION	6-1
6.1 AIR INLET INSTALLATION (<i>On Passenger's Side</i>)	6-1
7. SUPERCHARGER DISCHARGE	7-1
7.1 SUPERCHARGER DISCHARGE	7-1
8. FINAL CHECK OUT AND START UP	8-1
8.1 INSPECT THE FOLLOWING	8-1
8.2 PERFORM THE FOLLOWING	8-1
8.3 CHECK FOR THE FOLLOWING	8-1
APPENDIX	A-1
1016611 Asy, Mounting Bracket 5.0 Novi 2000	A-2
1016710 Asy, Crank Pulley 86-93 5.0 Novi 2000	A-3

IMPORTANT NOTE

This kit will require the purchase of a 4150 based Holley or Demon carburetor with mechanical secondaries.

1985 Ford Mustang Carbureted System

Installation Instructions

PLEASE READ CAREFULLY

This kit should only be installed by qualified mechanics. **It is imperative that the correct air/fuel mixture be maintained at all times. This Kit is to be supplied to competent engine tuners for their completion by the addition of, and tuning of, an appropriate carburetor unit.**

This product is intended for use on healthy, well maintained engines. Installation on a worn-out or damaged engine is not recommended and may result in failure of the engine.

Paxton Automotive is not responsible for engine damage. Installation on new engines will not harm or adversely affect the break-in period so long as factory break-in procedures are followed.

This kit is not smog legal for on-highway use.

For best performance and continued durability, please take note of the following key points:

1. Use only premium grade fuel 91 octane or higher (R+M/2).
2. The engine must have stock or lower than stock compression ratio.
3. If the engine has been modified in any way, check with Paxton prior to using this product.
4. Always listen for any sign of detonation (pinging) and discontinue hard use (no boost) until problem is resolved.
5. Perform an oil and filter change upon completion of this installation and prior to operating the vehicle. Thereafter, always use a high grade SF rated engine oil or a high quality synthetic, and change the oil and filter every 3000 miles.

TOOL AND SUPPLY REQUIREMENTS:

- Factory Repair Manual
- 3/8" Drive and Socket Set: SAE and Metric
- 1/2" Drive and Socket Set: SAE and Metric
- Open End Wrenches: SAE and Metric
- Center Punch
- SF Rated Quality Engine Oil
- Loctite Sealer #RC-609
- Oil Filter, and Wrench
- Heavy Grease
- Silicone Sealer
- Teflon Paste Sealant
- TAP, 3/8-18 NPT

Never rely solely on a hydraulic lift, when working under a vehicle. Always use approved jackstands to support the vehicle and place them under the manufactures recommended lift points.

When lifting the vehicle, make sure it is on a level surface, preferably concrete or asphalt. The transmission should be in "PARK" or "FIRST", the parking brake engaged, and the wheels blocked.

Never start the car with out first verifying that the transmission is in neutral and the parking brake is set.

Never remove the radiator cap while the engine is still hot. Always wear eye protection when using power tools such as drills, saws, grinders, etc., or when working under a vehicle.

Never smoke, use an open flame, or have spark-producing items around gasoline or flammable solvents. Always have a fire extinguisher rated for chemical and electrical fires handy when working on motor vehicles.

Run engines only in a well ventilated area.

Carbon monoxide, gasoline and solvent vapors are colorless, and sometimes odorless. These can asphyxiate or explode without warning.

Always disconnect at least the (-) negative or ground terminal of the battery when doing any electrical, fuel system, or under dash work.

We look forward to hearing from you, particularly if you have any comments or suggestions regarding this manual at (805) 604-1336 Paxton Automotive Corporation, 1300 Beacon Place, Oxnard, CA 93033. E-mail Address:

info@paxtonauto.com

*****NOTE*****

Through these procedures the word "discard" is used periodically in relationship to items that will no longer be utilized in conjunction with the supercharger installation. It is recommended that these items be saved for future use should it become necessary.



1985 Ford 5.0L Mustang

Part No. 1001845

PARTS LIST

IMPORTANT: Before beginning installation, verify that all parts are included in the kit. Report any shortages or damaged parts immediately.

PART NO.	DESCRIPTION	QTY.	PART NUMBER	DESCRIPTION	QTY.
8PM205-012	CARB. ENCL ASY, PAXTON SBF	1	4FA130-036	OIL DRAIN ASY	1
7A312-078	5/16-18 x 3/4" SHCS, S'STL	16	7U030-036	1/2" OIL DRAIN HOSE	2
7A312-252	STUD, 5/16" - 2.1/2" CARB ENCLOSURE	4	7P375-017	3/8"NPT x 1.2" BEADED HOSE BARB	1
7C011-050	10-32 PLUG SCREW	1	7R001-008	#8 STNL HOSE CLAMP	2
7F312-024	5/16-24 JAM NUT	4	70000	INSPECTOR NUMBER	0
7J312-000	5/16" FLAT WASHER-SAE	4	1016420	S/C ASY, 5.0 CARB. SERP N2K CUR	1
7F187-102	-3 BULKHEAD FITTING TO 1/4" HOSE	3	4PFX101-001	FUEL PUMP ASY, SBF CARB MECH.	1
7P187-103	PLUG, -3 O-RING PORT	1	7P125-016	1/8"NPT PLUG	1
7P250-084	1/4"NPT x 1/2" x 90° BARB	1	7P250-043	1/4"NPT x 5/16" BARB	1
7P375-104	PLUG, 3/8-16, BRASS, SHORT	3	7P250-047	1.4"NPT x 3/8" BARB x 90°	1
7P500-087	PLUG, AN-8 O-RING PORT	3	7P250-141	-6 JIC PUSH ON HOSE END, 90°	1
7U100-003	O-RING 3-903	4	7P500-083	-8 HOSE END STR, AL PUSH-ON	1
7U100-008	O-RING 3-908	3	7P500-084	MAKE JIC TEE, -8, -6, -6	1
7U100-020	10-32 GASKET	1	7P500-085	FTG, BULKHEAD -8 w/o RING	1
8M001-017	HOLLEY 4-BARREL BASE GASKET	2	7P500-086	-8 HOSE END, PUSHLOC 120°	1
8M001-018	GASKET, 90mm THROTTLE BODY	1	7P500-087	PLUG, AN-8 O-RING PORT	1
8PM003-051	CARB. COVER, PAXTON MACH.	1	7P500-089	NUT, -8 BULKHEAD BLACK	1
8PM105-012	CARB. ENCL. LOWER w/BUSHING, SBF	1	7P500-377	-8 JIC MAKE ORB TO -6 MAKE FLA	1
1016611	ASY, MTG BRKT, 5.0 N2K	1	7R001-006	#6 STNLS HOSE CLAMP, NARROW	4
1210508	ASY, PULLEY SMOOTH FACE	2	7U030-046	5/32" VACUUM LINE	4.5'
2A017-875-11	SPACER, .875"OD x 1.482" LONG	4	7U032-016	3/8" EFI FUEL HOSE, HI-PSR	2.5'
4FA011-021	MOUNTING BRACKET, S/C	1	7U037-030	-8 USCG FUEL HOSE, PUSH-ON	.45'
4FA015-015	ALTERNATOR STAY - PLATED	1	7U100-008	O-RING 3-908	3
4FA017-021	SPACER, SMOG PUMP	1	8F001-120	FUEL PUMP, SBF MECH, 120 GPH, 6-PSI	1
4PFA010-031	BRACKET, IDLER ADJUST SCREW	1	8H040-020	FUEL FILTER, INLINE 3/8"	1
4PFA010-044	PLATE, REAR S/C MTG, NOVI 2K	1	1017300	ASY, SMOG PUMP MOD.	1
4PFA010-054	PLATE, FRONT S/C MTG BRACKET, NOVI	1	4PFA012-101	MACH, SMOG PUMP ELBOW	1
4PFA017-011	COLLAR, 10-RIB PLY, NOVI	2	7P375-075	3/4" HOSE BARB UNION, BRASS	1
4PFA017-071	SPACER, BRACKET, DUAL 1.482	1	7R002-010	#10 SAE TYPE "F" SS HOSE CLAMP	4
7A250-077	1/4-20 x .75" FLAT ALLEN GR5	2	7U038-030	1/4" VACUUM HOSE	1'
7A375-100	3/8-16 x G5 HHCS, PLT	2	7U038-000	3/4" HEATER HOSE	.30'
7A375-102	3/8-16 x 1" FHCS, ZINC, PLT	3	4PFX130-351	OIL FEED ASY, SBF, '69 351	1
7A375-124	3/8-16 x 1-1/4" HHCS, G5, PLATE	4	7P125-004	1/8"NPT x 90° x -4 JIC FTG STL	1
7A375-175	3/8-16 x 1-3/4" HXHD GR5 PLT	1	7P250-034	1/4"NPT x 1/4"NPT STREET TEE	1
7A375-200	3/8-16 x 2" HXHD GR5 PLTD	1	7P250-031	1/4"NPT x -4 JIC FLARE FTG STL	1
7A375-251	3/8-16 x 2-1/2" FLAT SHCS	1	7U250-090-320	OIL FEED HOSE, 32" -4 x 90°	1
7A375-300	3/8-16 x 3" HXCS GP5 P	3	7U100-055	TIE-WRAP, 7.5" NYLON	2
7A375-302	3/8-16 x 3.0 FLAT HD PLATED	2	4PFX212-050	ASY, AIR INTAKE 5.0 CARB SERP.	1
7A375-625	3/8-16 x 6-1/4" HXHD	1	7PS400-200	SLEEVE, BLACK 4"OD x 2.0"	1
7A375-650	3/8-16 x 6-1/2" HX GR5 ZINC	1	7R002-064	#64 SAE TYPE "F" SS HOSE CLAMP	2
7A375-675	3/8-16 x 6.75" HXHD GR5 ZINC	1	4PFX012-051	ELBOW, 90° MOD CAST 4" x 3.5" w/HOL	1
7A375-751	3/8-16 x 7.5" HXHD GR8 ZINC	1	7U035-001	3-1/2" FLEX HOSE	1'
7A437-175	7/16-14 x 1.75 HXHD ZINC PLT	1	7R002-052	#52 SAE TYPE "F" SS HOSE CLAMP	2
7B500-300	1/2-20 x 3.00" HXHD GR5 ZINC	1	4H110-060	FLANGE ASY, AIR BOX S2000	1
7F375-016	3/8-16 HX NUT	2	7PS375-200	SLEEVE, BLACK Ø3.75" x 2.0"L	1
7F500-025	1/2-20 HEX NUT PLATED GR5	2	7R002-056	#56 SAE TYPE "F" SS HOSE CLAMP	2
7J375-044	3/8"SAE WASHER PLATED	17	4FA012-012	INTAKE ELBOW, 90° w/o BOSSES	1
7J438-081	7/16"SAE WASHER, PLATED	2	8H040-030	AIR FILTER 3.5" FLG x 6"L	1
7J500-001	WASHER, 1/2"ID x 1.12"OD	3	7U033-000	5/8" PCV HOSE	2'
7PA375-500	SCREW, IDLER ADJUST, 5.00"	1	7P250-048	1/4"NPT-5/8"BARB x 90°	1
7PB500-263	ARBOR, S/C TENS PLY, 5.0 N2K	1	7P250-047	1/4"NPT-3/8" BARB x 90°	1
1016710	ASY, CRANK PULLEY	1	7U030-046	5/32" VACUUM LINE	3.5'
2A041-568	BELT, DAYCO 5100568 10-RIB	1	7P375-075	3/4" HOSE BARB UNION, BRASS	1
2A046-888	BELT, 6-RIB x 88.82" EFFECT. LE	1	7R002-010	#10 SAE TYPE "F" SS HOSE CLAMP	2
4FA018-023	4.75/6.87" 10-GRV CRANK PULLEY	1	7E010-049	#10 x 3/4" HXHD SLF DRL SHT MTL	4
7A375-158	3/8-16 x 1.5" SHCS GR8 PLTD	4	4PFX212-060	ASY, DISCHARGE 5.0L CARB. SERP.	1
7K375-040	3/8"AN960 FLAT WASHER PLATED	4	4PFX012-021	MACH, DISCH TUBE, SBC CARB	1
4FA114-023	RADIATOR HOSE ASY	1	7PS300-300	SLEEVE, BLACK, 3.0"OD x 3.0"L	1
4FA114-011	RADIATOR PIPE POLISHED	1	7PS350-301	REDUCE, BLK 3.5-3.0 x 3.0L	1
7R002-024	#24 SAE TYPE "F" SS HOSE CLAMP	2	7R002-044	#44 SAE TYPE "F" SS HOSE CLAMP	3
7000	INSPECTOR NUMBER	0	7R002-052	#52 SAE TYPE "F" SS HOSE CLAMP	3
1017400	TENSIONER, BELT, KIT	1	7R002-016	#16 SAE TYPE "F" SS HOSE CLAMP	4
4FA010-011	TENSIONER MTNG. BRACKET MACH	1	8D001-001	STD COMPRESS BYPASS VALVE	1
7A375-124	3/8-16 x 1-1/4" HHCS, G5, PLATE	2	7U034-016	1" GS HEATER HOSE	1
7A500-350	1/2-13 x 3-1/2" CARRIAGE	1	7P750-102	3/4"NPT x 1" x 90° HSE FIT	1
7F375-016	3/8-16 HEX NUT	1	8M003-041	MACHINE, Ø3.5" FLANGE, SATIN	1
7F500-013	1/2-13 HEX NUT	1	7U030-046	5/32" VACUUM LINE	1
7J375-044	3/8"SAE WASHER, PLTD	1			
7J500-001	WASHER, 1/2"ID x 1.12"OD	1			



1985 Ford 5.0L Mustang

Part No. 1001845

PARTS LIST

IMPORTANT: Before beginning installation, verify that all parts are included in the kit. Report any shortages or damaged parts immediately.

PART NO.	DESCRIPTION	QTY.	PART NUMBER	DESCRIPTION	QTY.
8M110-085	ASY, SUPPORT 5.0"L CARB SERP	1			
7P375-045	3/8"NPT M/F x 45° STREET ELBOW	1			
7U031-016	5/16" PCV/VAC RUBBER HOSE	2'			
4PFA017-051	SPACER, FAN .510" PILOT NOVI	2			
7U313-250	STUD, 5/16-24/24 x 2.5"4	1			
7J312-000	5/16" FLAT WASHER, SAE	4			
7L312-000	5/16" SPLIT (LCK) WASHER	4			
7F312-021	5/16-24 NUT	4			
5W013-000R	1/0 RED BATTERY CABLE	5'			
5W001-029	LUG END TERMINALS 1/0	2			
5W001-008	3/4" HEAT-SHRINK TUBING	.33'			
7A375-100	3/8-16 x 1" GS HHCS, PLT	2			
7F312-017	5/16-18 NYLOCK NUT	2			
7J375-044	3/8" SAE WASHER, PLTD	4			
4GF055-010	WASHER, RESERVOIR GM TPI	1			
7U313-300	STUD, 5/16-18/24 x 3.0" LG	4			
8M001-019	GASKET, 4BRRL CARB. w/EGR FORD	1			
8M017-021	SPACER, CARB. w/EGR BLK OFF	1			
7U313-300	STUD, 5/16-18/24 x 3.0"LG	4			
8M001-019	GASKET, 4BRRL CARB. w/EGR	1			
8M017-021	SPACER, CARB. w/EGR BLK OFF	1			
8M110-120	DEMON PLT BWL LINE ASY w/FTGS	1			
88M010-120	FUEL LINE, SS FRONT DEMON	1			
8M010-130	FUEL LINE, SS REAR DEMON	1			
7P375-046	FTG, -6 TO 9/16-24 BG ADAPTER	2			
8M110-080	ASY, THROTTLE, LINK '85 MUS	1			
8M001-060	CABLE, THROTTLE	1			
8M010-170	BRKT, CHVY THROTTLE CABLE	1			
8M010-081	RETAINER, THROTTLE SPRING	2			
8M010-190	BRKT, THROTTLE RETURN SPRING	1			
2A017-750-03	SPACER, .750"OD x .130" LONG	1			
2A017-032	SPACER, CARB. ENCLOSURE	1			
7C010-052	10-24 x 1/2" BUTTON-HEAD SCREW	3			
7C010-077	10-24 x 3/4" BUTTON-HEAD CAP SCREW	2			
7C010-187	ROD END, 3/16", RH THREAD, w/NUT	1			
7C010-188	ROD END, 3/16", LH THREAD, w/NUT	1			
7F010-026	NUT, THROTTLE	1			
7J010-001	#10 FLAT WASHER	8			
7J010-687	WASHER, THROTTLE ENCLOSURE	1			
8M010-040	THROTTLE ARM-INNER ENCLOSURE	2			
8M010-050	THROTTLE SHAFT-ENCLOSURE	1			
8M010-090	SPRING, THROTTLE ENCLOSURE	1			
8M010-140	SHAFT, 5/16" HEX	1			
7P375-104	PLUG, 3/8-16, BRASS, SHORT	1			
4PFX020-020	MANUAL, 5.0 MUS. CR. SERP N2K	1			
008575	S/C STRT INFO PKG ASY PAXT	1			
3863515	DECAL, PAXTON COLOR 9" x 3"	1			

Section 1

PREPARATION AND REMOVAL

***** NOTE *****

If vehicle has gone more than 10,000 miles since it's last service. It is recommended that new spark plugs (no platinum) be installed and that the ignition timing be set to 6-8° initial unless using an aftermarket timing box such as the MSD 6AL-BTM. The complete ignition system should be in good working condition before beginning installation. IE. distributor cap and rotor, spark plug wires, etc.

1.1 Preparation and Removal.

- A. Disconnect the battery cables; remove battery hold down, battery, and battery mounting tray. Set these aside to reinstall later.
- B. Remove the complete air cleaner assembly, including the two plastic inlet Ducts located in the inner fender wells (driver & passenger sides). (See Fig. 1-a.)



Fig. 1-a

- C. Disconnect the electric choke wire from the carb. and cut at the alternator harness.
- D. Disconnect the fuel line from the carb. Remove the throttle cable and bracket from the car and discard. (See Fig. 1-b.)



Fig. 1-b

- E. Disconnect all vacuum, pcv, and egr lines from the carb. Labeling each lines function will help to reinstall to their correct positions later.
- F. Remove the four retaining nuts and washer securing the carburetor to the manifold. Remove the carburetor, EGR plate, and four studs from the manifold. Discard these items.
- G. Remove the Thermal Vacuum Switch at the rear of the manifold. Using the supplied 45° brass street elbow, reinstall the switch pointing to the passenger side rear of the vehicle. Reconnect the thermal switch plug. This will allow clearance for the carburetor enclosure. (See Figs. 1-c, 1-d.)

***** NOTE *****

Use pipe sealant on the threads of both the fitting and the switch.

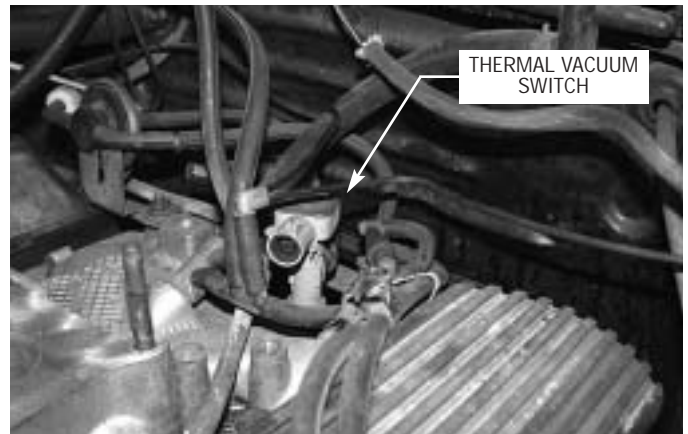

Fig. 1-c



Fig. 1-d

- H.** Disconnect the slide connection plug on the coil. Remove the coil and coil bracket from the manifold. Reinstall the coil in it's original bracket to the A/C bracket bolt. (See Fig. 1-e.)



Fig. 1-e

Split the wire loom to gain the necessary wire length to reach the new coil location. Reconnect the slide connector to the coil. (If enough length can not be obtained use the supplied wire and butt connectors to lengthen.)

***** NOTE *****

If a longer coil wire is needed, source a universal coil wire kit that can be used. However, this would be a good time to replace a worn wire set.

- I.** On the passenger side of the A/C condenser, remove the A/C line support bracket and discard. (See Fig. 1-f.)

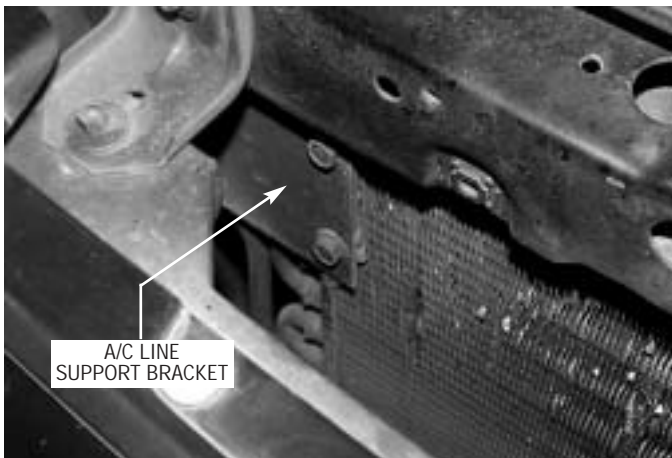

Fig. 1-f

- J.** Relocate the starter solenoid to the driver's side just in front of the shock tower. (See Fig. 1-g.)



Fig. 1-g

The ignition switch wire (and any other wires drawing power from the solenoid) will need to be extended to the new location.

- K.** Relocate the battery tray to the driver's side. Use the two 3/8" x 1" bolts, washers, and nuts provided to secure the tray to the engine compartment. Re-install the battery and factory battery hold down. The battery ground cable should be grounded to the engine block. The battery positive cable is reconnected to the starter solenoid. The starter cable will need to be replaced with the longer cable provided to reach the solenoid's new location. Route and secure away from heat and moving parts.
- L.** Locate the steel vacuum tube near the driver's side valve cover. Using the supplied 5/16" x 24" rubber hose, connect this to the vacuum tree on the firewall. Route as shown or for best possible carburetor linkage clearance. (See Fig. 1-h.)

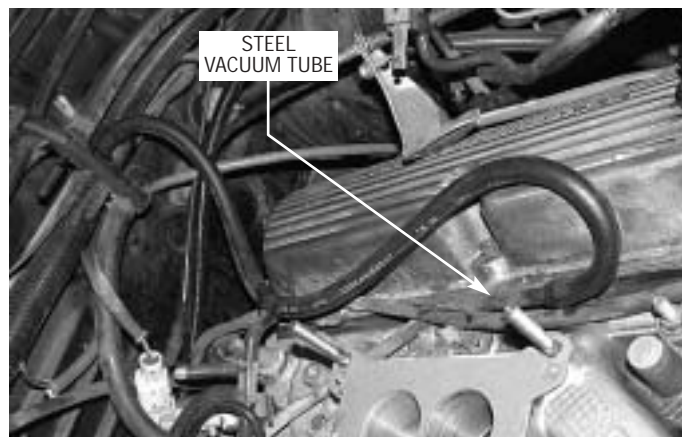

Fig. 1-h

- M.** Thoroughly clean the intake manifold carburetor flange. Thread the supplied (4) carburetor studs into the intake manifold. And install one of the supplied gaskets.

- N. Loosen the petcock at the bottom of the radiator and drain approximately one gallon of coolant into a drain pan. (*Save fluid for re-use.*)
- O. Disconnect the overflow hose from the neck of the radiator. Remove the coolant bottle and discard.
- P. Using a 7/16" combination wrench, loosen the four bolts that are securing the fan to the water pump. With an 18mm combination wrench release the tension on the belt tensioner and remove the factory drive belt. Now remove the four bolts that are securing the fan to the water pump. (See *Figs. 1-i.*)

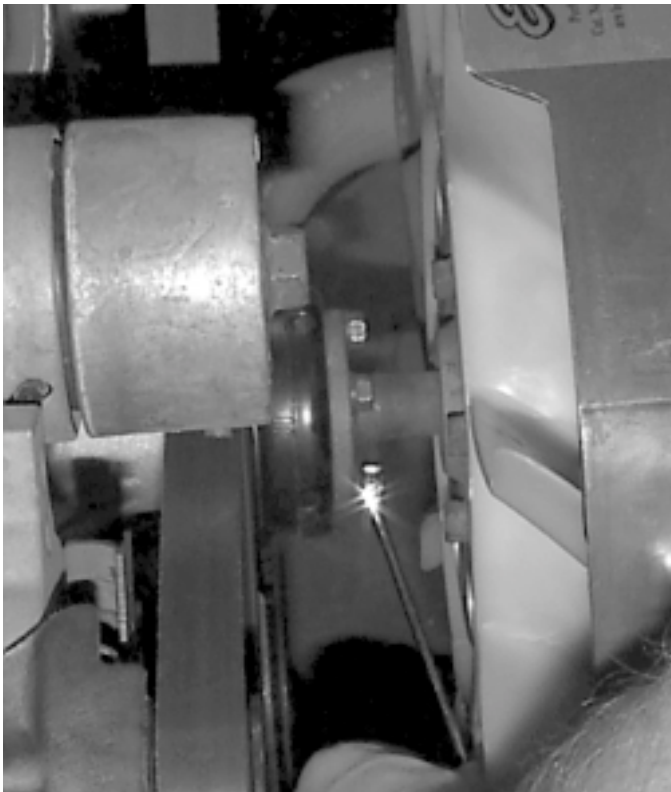

Fig. 1-i

- Q. Using a 10mm socket & ratchet or screw driver, loosen the clamps and remove the upper radiator hose from the vehicle. *Save for re-use.* (See *Fig. 1-j.*)



Fig. 1-j

- R. Using a 7/16" wrench or socket, remove the two sheet metal screws securing the fan shroud to the radiator core support and remove the fan shroud, fan clutch and fan from the vehicle. (See *Fig. 1-k.*)



Fig. 1-k

- S. Using a 19mm wrench, loosen the bolt securing the accessory drive belt tensioner to the factory bracket and remove the tensioner from the bracket. Set aside to be used in a later step of the installation. (See Fig. 1-l.)



Fig. 1-l

- T. Unplug the electrical connection at the alternator, and using a 9/16" and a 1/2" socket, remove the alternator from the factory bracket. (See Fig. 1-m.)

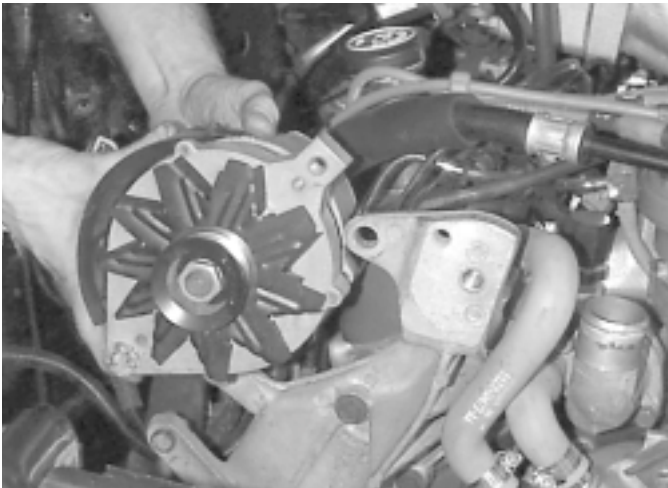

Fig. 1-m

- U. Using a 5/16" nut driver, loosen the clamps and remove the air injection hose from the smog pump and diverter valve up next to the valve cover. Disconnect the vacuum line behind the smog pump and remove the hose from the vehicle. Set aside for re-use
- V. Remove the bolt at the rear of the smog pump using a 9/16" socket and the two at the front of the pump, remove the smog pump from the vehicle.

- W. For supercharger clearance, it is necessary to replace the stock 90° hose port on the smog pump with the smaller piece provided. Locate the supplied assembly and replace the stock piece now. (See Fig. 1-n.)



Fig. 1-n

- X. Using a 9/16" socket and extension, remove the remaining bolts securing the factory bracket to the engine. Set the bracket aside, this bracket will not be re-used.
- Y. On the frame rail, there is an evaporator canister. From underneath the vehicle, use a 1/2" socket and remove the two bolts securing the canister bracket to the frame rail. Reposition the canister forward, towards the front of the vehicle, using one of the stock bolts. Resecure the canister to the frame rail using the forward hole in the frame rail and the rear hole in the bracket.

- Z.** Remove the four factory crank pulley bolts with a 9/16" socket and extension and remove the pulley from the vehicle. (See *Fig. 1-o.*)

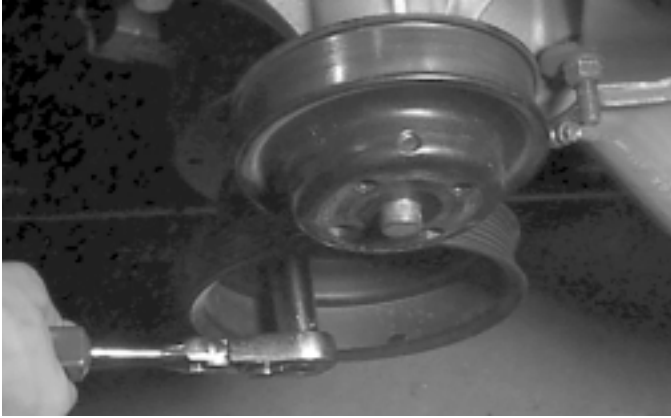

Fig. 1-o

This Page Left Intentionally Blank

Section 2

SUPERCHARGER OIL DRAIN AND OIL FEED ASSEMBLY

2.1 Supercharger Oil Feed Assembly

- A. Remove the oil pressure sending unit located near the oil filter. Apply clean motor oil to the threads of the supplied street TEE. Install the TEE with the branch facing the front of the engine, referring to *Fig. 3.1-a* for positioning.



Fig. 2-a

- B. Install the 1/8" x -4 fitting in the branch of the TEE and connect the supplied oil feed line. Route the line up toward the passenger side valve cover behind the accessory brackets. Secure line away from any moving parts. Cap the line to prevent debris from entering until the line is connected in a later step.
- C. Reinstall the factory oil pressure sending unit in to the end of the street TEE, and connect the factory wire harness.

2.2 OIL DRAIN ASSEMBLY

*****IMPORTANT*****

Before continuing, drain the motor oil from the vehicle.

- A. From underneath the vehicle you will need to drill a pilot hole in the oil pan on the passenger side by using a 1/8" drill bit approximately 1-1/2" from the top and 2" from the front of the oil pan. (See *Fig. 2-b*.)



Fig. 2-b

- B. Upon completion of the drilled pilot hole, insert a rigid thin piece of wire through the drilled pilot hole to ensure that there is a straight shot for the punch to go into. If there is anything blocking the path, rotate the engine by hand using the appropriate size socket and ratchet, to rotate the crankshaft. Insert the punch into the pilot hole and evenly enlarge the hole to 9/16".
- C. Using a 3/8"NPT tap (not supplied) tap the punched hole to accommodate the threaded brass fitting. Before tapping, coat the tap with thick lithium grease to retain the metal shavings while you tap the oil pan. Upon completion of the tapped oil pan hole, coat the threaded end of the brass fitting with silicone and thread into the oil pan, be cautious not to over tighten or to strip the oil pan threads.

This Page Left Intentionally Blank

Section 3

SUPERCHARGER BRACKET ASSEMBLY

3.1 Crank Pulley Assembly

- A. With the 4 supplied bolts $\frac{3}{8}$ x 1 in length install the new crank pulley and torque the bolts to 25-28ft pounds. (See Fig. 3-a.)

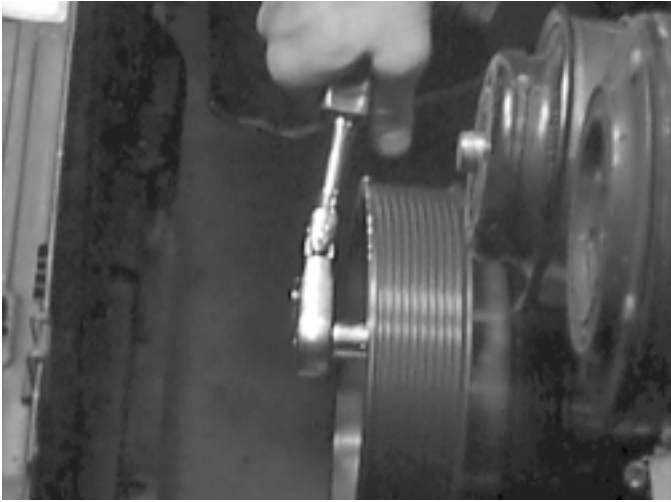

Fig. 3-a

3.2 Supercharger Bracket Assembly and Mounting

- A. Locate the supercharger mounting bracket assembly #101661 and the cast supercharger mounting bracket. Also locate the $\frac{3}{8}$ " x 6.5" long bolt, $\frac{3}{8}$ " x 6.25" bolt, the $\frac{3}{8}$ " x 2", and insert them into the rear of the cast mounting bracket. (See Fig.3-b.)

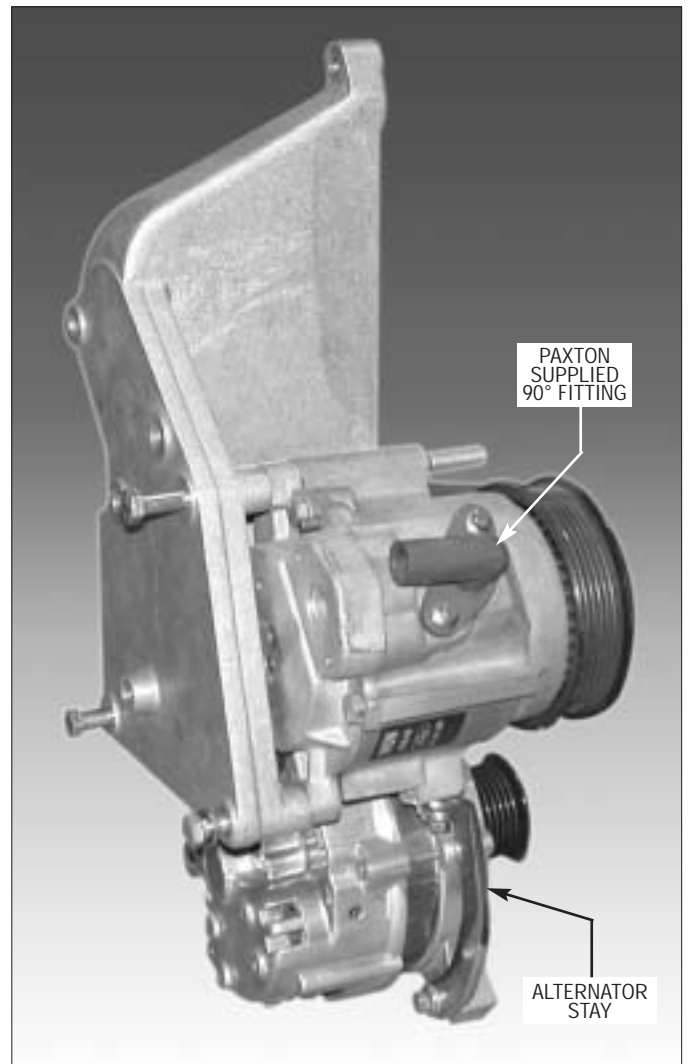

Fig. 3-b

- B. Attach the alternator stay bracket to the boss on the bottom of the smog pump using the $\frac{3}{8}$ " x 1" bolt and washer provided. (See Fig. 3-c.)

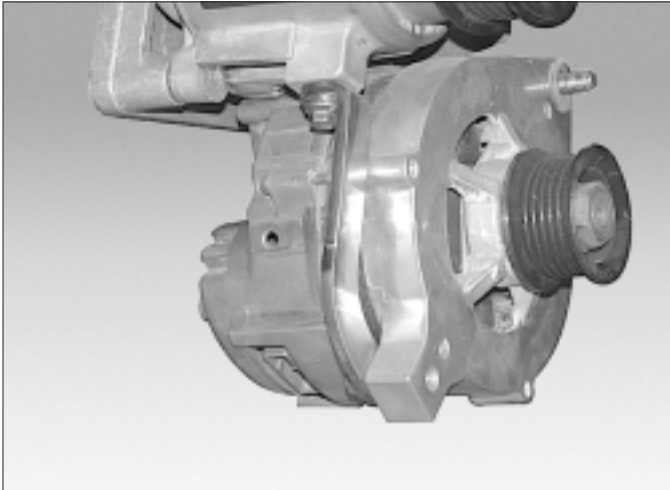

Fig. 3-c

***** NOTE *****

Leave these bolts loose. All bolts will be tightened once the bracket is installed on the motor.

- C. With the smog pump and the alternator as an assembly. Slide them over the bolts previously installed into the cast bracket. Locate the small spacer that will go between the smog pump and the main supercharger mounting bracket. Install this spacer onto the upper-most bolt of the smog pump. (See Fig. 3-d)

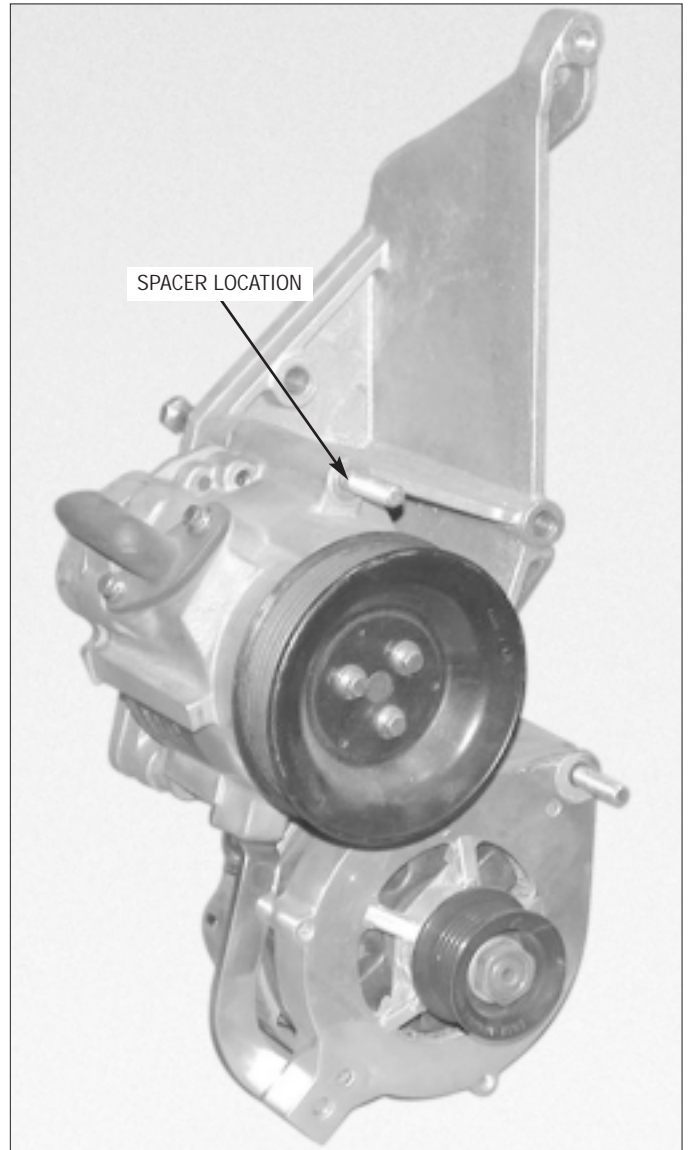

Fig. 3-d

- D. Install the large supercharger mounting plate over the bolts that were previously installed through the cast bracket. (See Fig. 3-e.)

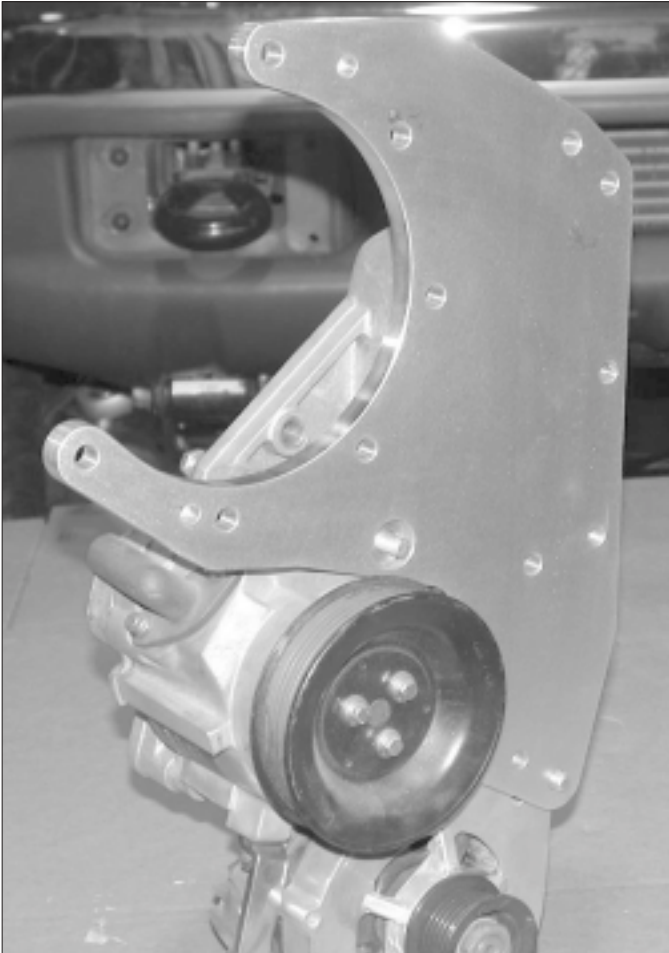

Fig. 3-e

- E.** Locate nuts and washers and secure the supercharger mounting plate. Leave these nuts loose.
Locate the 7/16-14 1.75" bolt and washer and the 3/8-16 x 1.75" bolt and washer, the 3/8-16 x 6.75" bolt and washer. Install these bolts as noted in Appendix #1016611. Install this assembly as a unit to the engine and tighten all bolts and nuts.
- F.** Install the 90° x -4 fitting using engine oil only on the threads going into the supercharger. Attach the oil drain hose to the fitting and route the hose so there are no kinks or dips. See that it is routed away from hot or sharp objects and there are no kink or dips in the line.
- G.** Install the supercharger into the supercharger mounting plate using three of the 3/8-16 x 1.25" bolts and the 3/8" washers. Refer to Appendix #1016611 for their location. When attaching the belt tensioner plate, it is recommended that the use of anti-seize be used on the heads and threads of the counter-sunk bolts.

- H.** Bolt the Supercharger to the mounting bracket with one of the 3/8" x 1" bolts and washers through the upper most hole and the two lower holes in the mounting plate. Place the support plate over the front of the supercharger and secure with the 3/8" counter-sunk bolts. (See Fig. 3-f.)

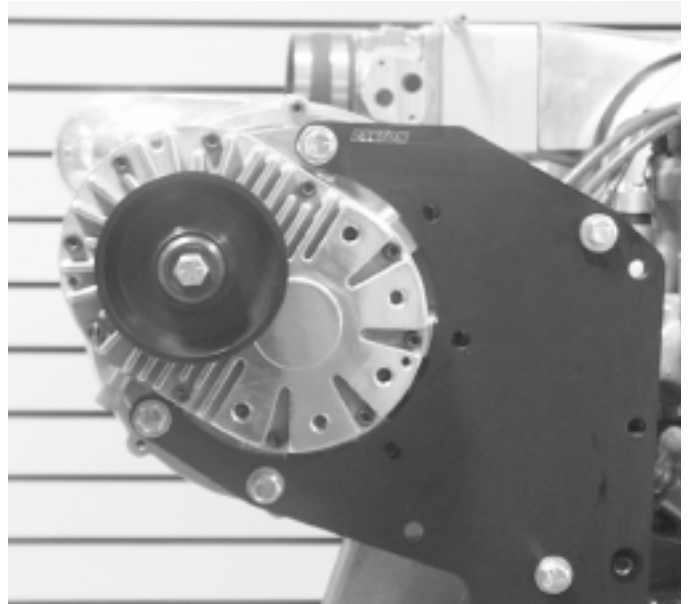

Fig. 3-f

- I.** Connect the oil drain hose to the previously installed fitting in the oil pan. Secure using a #8 hose clamp. Trim for best fit so there are no kinks or sharp bends in the hose.
- J.** Connect the previously install oil feed line to the -4 x 90° fitting on the supercharger. Position as shown in Fig. 3-g and secure to the bracket.



Fig. 3-g

***** NOTE *****

You will have to route the accessory drive belt before installing the supercharger belt tensoning plate. See Appendix #1016710.

- K. Locate the supercharger belt tensoning plate. Assemble the idler pulley and supercharger belt tensoning assembly. (See Fig. 3-h.)

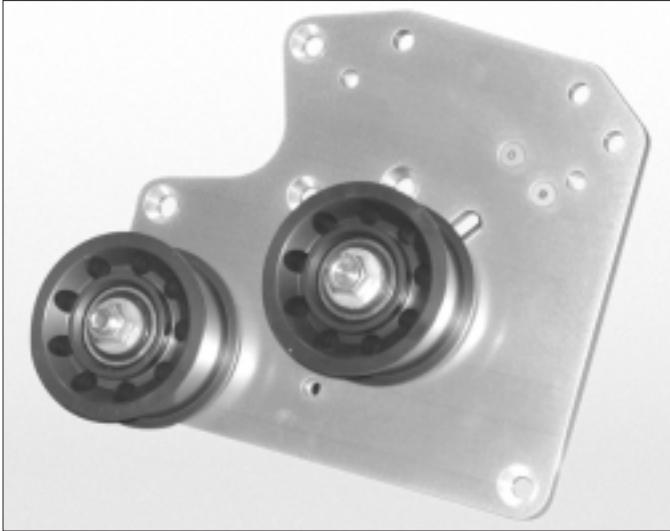

Fig. 3-h

- L. Attach the supercharger belt tensoning plate to the supercharger and rear supercharger mounting plate using the spacers, bolts and washers provided. Refer to Appendix #1016611 for their location.

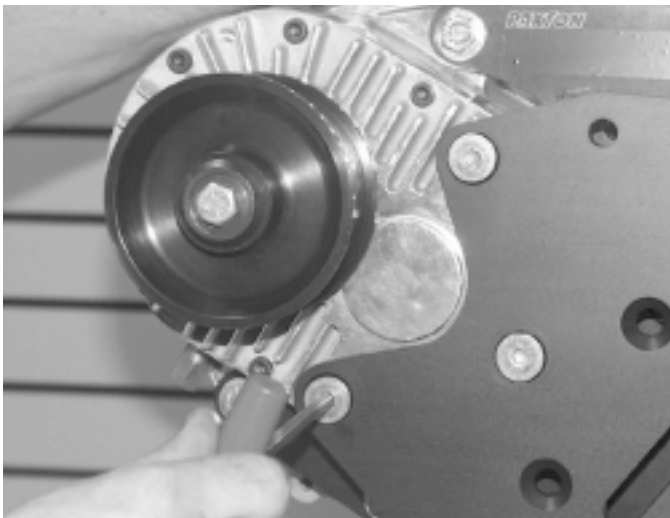

Fig. 3-i

- M. Install the 3/8" x 2 1/2" countersunk bolt through the lower most hole in the support plate and thread it into the mounting plate. Do not tighten this bolt. (See Appendix 1016611.)

- N. Above that, insert two of the 3/8" x 3 1/4" bolts with washers through the support plate, spacer and mounting plate. Secure the accessory drive belt tensoner to the back of the mounting plate with the upper of these two bolts holes, the lower with the 3/8" x 1" bolt and washer provided. Secure the other side of the belt tensoner bracket to the stud at the top of the water pump with the 3/8" nut and washer. Do not tighten these bolts. (See Fig. 3-j)



Fig. 3-j

- O. There are three (3) countersunk holes left in the support plate. They each take the remaining 3/8" x 3 1/4" counter sunk bolts. Install these bolts and tighten to 28-30 ft pounds. Upon completion of this step, tighten all of the remaining bolts that have been left hand tight, as well as the Smog and alternator assemblies.
- P. Use the supplied 1/2" x 3 1/2" carriage bolt, nut and washer to secure the factory belt tensioner to the new bracket. Tighten nut to 28-30 ft lbs.. (See Figs. 3-j, 3-k.)



Fig. 3-k

- Q. Use an 18mm wrench to rotate the accessory belt tensioner and reinstall the factory belt. (See *Appendix 1016710*.)
- R. Install the supercharger drive belt between the crank pulley and the supercharger pulley. Route the belt inside the idlers. Use a 3/8" socket and extension and tighten the belt. Once the belt is tensioned, tighten the nut on the end of the adjustable idler so that it will not back off.
- S. Find the rubber air injection hose from the diverter valve removed in an earlier step. Shorten the hose by cutting 3" out of the middle of the hose and 1-1/2" off the back of the hose. Reconnect the two formed pieces together with the sleeve and clamps provided. Re-install the short end hose between the diverter valve and fitting on the side of the smog pump. (See *Fig. 3-l*.)

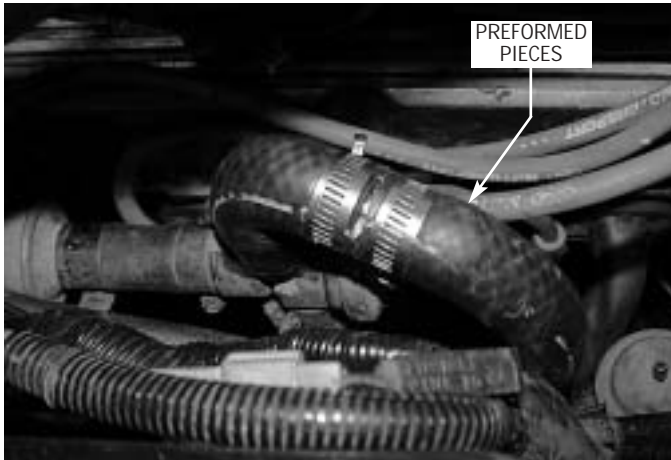

Fig. 3-l

- T. Cut the upper radiator hose. Re-install the longer piece on the thermostat housing angled forward. Install the shorter 90° degree piece on the radiator angled to the side. Install the stainless tube between the two pieces of hose and secure with the supplied clamps. (See *Fig. 3-m*.)

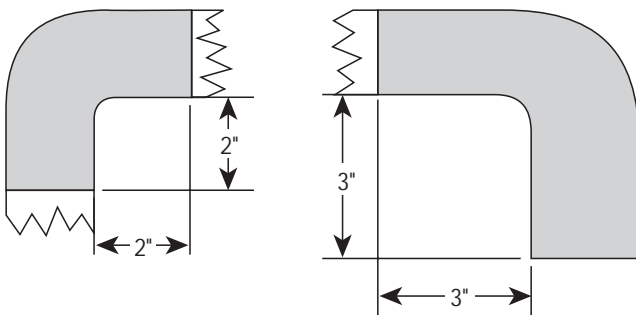

Fig. 3-m

- U. Trim the fan shroud as seen in *Fig. 3-n*. This is easiest with a pneumatic cut-off wheel.

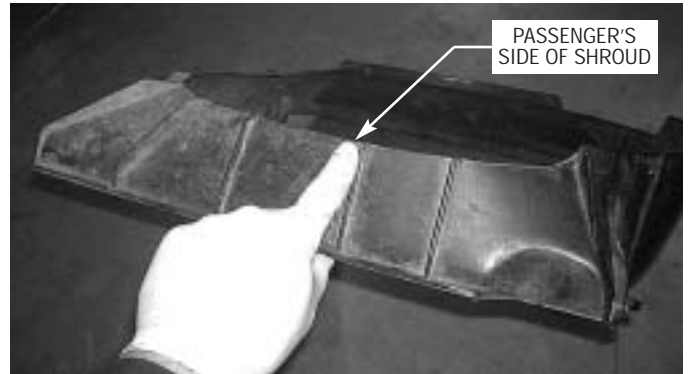

Fig. 3-n

*** NOTE ***

Only the bottom and passenger sides are trimmed.

- V. Install the supplied water pump pulley studs into the w/Pump flange. Slide the two supplied spacers stacked onto the studs. Re-install the fan shroud and fan assembly into the engine compartment. Attach the fan assembly to the water pump. Using the supplied washers and nuts to secure it, tighten to factory specifications. Use the factory screws to re-install the shroud onto the radiator core support.
- W. Locate the supplied radiator overflow bottle. Using it as a template, mark the two hole locations on the passenger's side inner fender. Drill a 1/8" pilot hole for each location. Using the supplied self-tapping screws, secure the overflow bottle in place. Route the supplied 5/16" x 5' rubber hose from the radiator fill port to the bottom of the overflow bottle. Refill the cooling system with coolant previously drained. (See *Fig. 3-o*.)

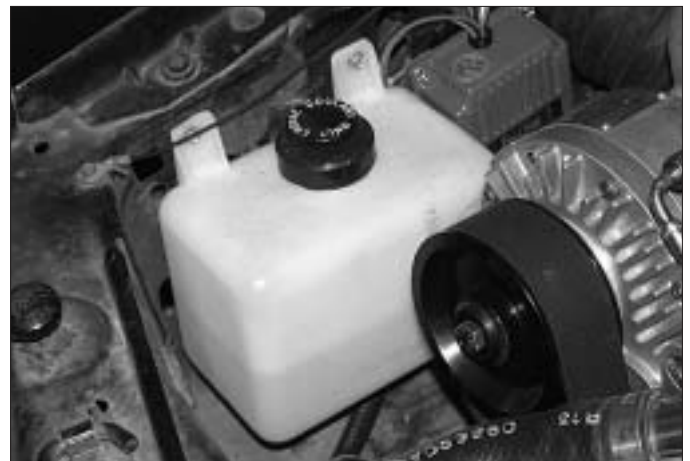

Fig. 3-o

This Page Left Intentionally Blank

Section 4

FUEL PUMP REPLACEMENT

4.1 FUEL PUMP REPLACEMENT

- A. Disconnect the fuel lines from the fuel pump.
- B. Remove the fuel pump.
- C. Install the supplied fuel pump and gasket using the stock hardware.
- D. Attach the supplied vacuum hose to the barb fitting on the fuel pump. The other end of this hose will be connected to the carburetor enclosure in a later step.
- E. Install the 1/4" NPT to 3/8" barb 90° in the fuel pump outlet.
- F. Install the 1/4" NPT to 5/16" barb straight in the fuel inlet. (See Fig. 4-f.)

*** NOTE ***

If the stock fuel pump has a return line to the fuel tank, cap this line or remove it from the vehicle and cap the tank.



Fig. 4-f / View from below the engine

- G. Re-attach the fuel supply line using the factory hose clamp.
- H. Attach the supplied 3/8" fuel line from the fuel pump outlet to the supplied fuel filter. Attach a piece of 3/8" fuel line to the filter-out and then route up to where the carburetor enclosure will be installed. Install and tighten the supplied hose clamps on all connections.
- I. Install the supplied -6 90° hose end into the open end of the 3/8" hose where it will connect to the bulkhead fitting on the carburetor enclosure.

This Page Left Intentionally Blank

Section 5

CARBURETOR ENCLOSURE INSTALLATION

5.1 CARBURETOR ENCLOSURE INSTALLATION

*** NOTE ***

Due to the many possible configurations of intake manifolds (with regard to carburetor flange height) a carburetor spacer may be required to obtain the necessary height for proper supercharger and discharge duct alignment. If hood interference is a problem, a lower profile intake manifold may be required. This kit was designed to work with the **stock manifold** for this application

*** NOTE ***

If possible, connect the PCV valve hose to a vacuum source on the intake manifold. If no source is available, connect to the 1/4" NPT hole in back of the enclosure.

- A.** Make sure the carburetor-mounting surface is clean and dry. Locate the 8M110-085 support assembly. Replace the factory carburetor studs using the 3.0" long studs (7U313-300) provided. Place the manifold to EGR spacer gasket (8M001-019) (gasket has provision for EGR) onto the manifold. Slide the supplied .50" thick EGR eliminating spacer over the studs until it seats flat on the surface. Install one of the provided carburetor gaskets (8M001-017) onto the spacer previously installed. (See Fig. 5-a.)

*** NOTE ***

The carburetor spacer provided is for use with the factory intake manifold and is designed to block off the EGR passage. After market intakes may not require the spacer to be used.

- B.** Install the lower part of the carburetor enclosure over the studs until it sits flat on the intake manifold.
- C.** Install the other carburetor gasket over the studs until it sits flat on the carburetor enclosure carburetor mounting surface.
- D.** Install the throttle nut through the large hole on the outside of the throttle arm. Using a 10-24 cap screw inserted through a rod end and the #10 fender washer, thread into the throttle nut and tighten. (See Figs. 5-b, 5-c.)

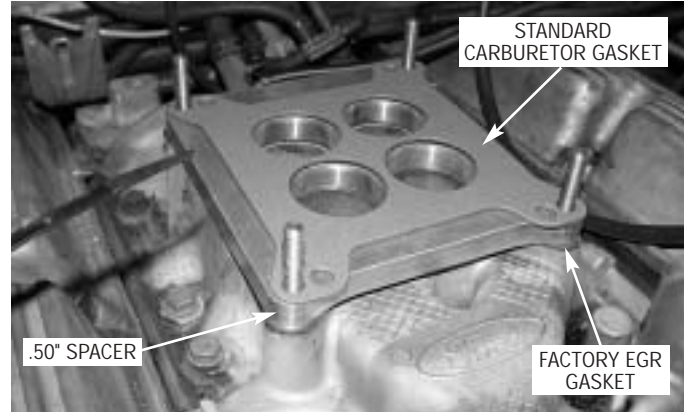

Fig. 5-a



Fig. 5-b

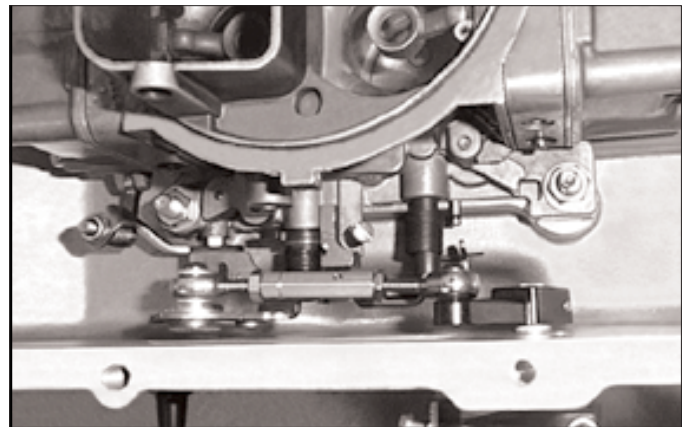

Fig. 5-c

- E.** Install two of the brass plugs in each side of the carburetor enclosure. (See Fig. 5-d.)

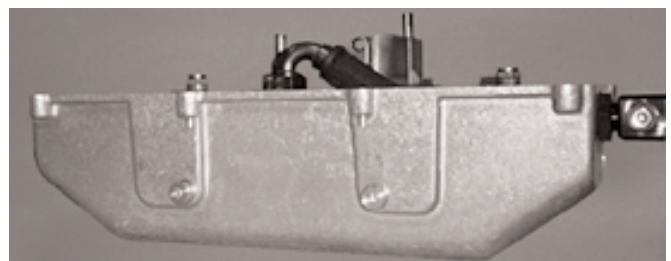

Fig. 5-d

- F. With the one armed throttle arm on the inside of the enclosure, insert the splined shaft through the throttle bushing on the side of the carburetor enclosure.
- G. Install the .130" long spacer over the splined shaft until it rests flat against the outside of the enclosure. (See *Fig. 5-h.*) Line up the remaining throttle arm with the inner throttle arm and slide onto the splined shaft.
- H. Tighten the clamp screws on both of the throttle arms. Rotate the throttle linkage to verify free movement. If drag is felt, adjust the distance between the two throttle arms.
- I. Install the remaining rod end on the outer hole on the inside of the inside throttle arm and tighten screw.
- J. Install the carburetor over the carburetor studs until it sits flat on the gasket. Install the four 5/16" nuts and washers on the studs and tighten. Make sure unused vacuum ports on the carburetor are plugged.
- K. With a jam nut installed on each rod end, install the 5/16" coupler shaft between the two rod ends. Adjust the coupler until the angle of the carburetor enclosure throttle arm matches that of the carburetor throttle arm.
- L. Install the fuel lines on the carburetor (See *Figs. 5-e, 5-f.*) as follows:
 1. Install the -8 bulkhead nut and O-ring on the bulkhead fitting.
 2. Thread the bulkhead fitting into the front hole in the carburetor enclosure.
 3. Install the fuel lines into the carburetor bowls loosely.
 4. Connect the free end of each fuel line to the -8/-6/-6 TEE.
 5. Install the -8 straight hosebarb fitting on the inside of the bulkhead fitting. Install the -8 120° fitting on top of the TEE.
 6. Measure and cut the supplied pushlock hose so that it will fit well between the two installed barb fittings.
 7. Remove the barbed fittings, coat the barbs with grease, and fully insert the barbed fittings in the hose.
 8. Install the fuel hose assembly and tighten all of the fuel line connections.

- M. Hose connections to the carburetor enclosure will vary widely depending on the application. All holes that are not used should be plugged with the supplied -3, -8 and 1/4"NPT plugs. The supplied fittings and lines were meant for a stock vehicle.

***** NOTE *****

All -3 and -8 fittings should have an O-ring installed before using.



Fig. 5-e

- N. Connect the vacuum hose previously attached to the small barb fitting on the fuel pump to a -3 bulkhead fitting in the enclosure. Leave the bulkhead fitting open on the inside of the enclosure.
- O. Connect the -6 90° hose end to the -6 fitting on the bulkhead fitting. (See *Fig. 5-f.*)



Fig. 5-f

5.2 THROTTLE CABLE INSTALLATION

- A. Using a small square file, file two grooves in the firewall where the throttle cable goes through. Reference the cable housing for dimensions.

*** NOTE ***

The grooves should be in the 12 and 6 o'clock positions.

- B. Install the cable in the firewall and connect to the stock accelerator pedal.
- C. Mount the throttle cable bracket to the carburetor enclosure using the supplied hardware. (See Fig. 5-g.)
- D. Secure the throttle cable to the mounting bracket.
- E. Install the throttle return-spring bracket to the linkage arm using one 10-32 x 1/2" button-head screw. (See Fig. 5-f.)

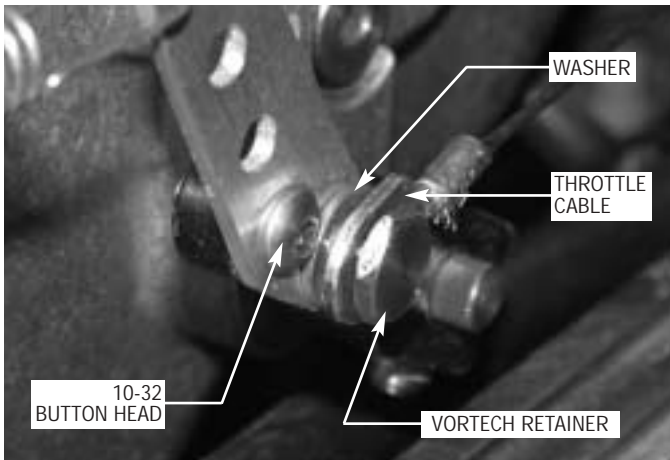

Fig. 5-g

- F. Connect the cable to the linkage arm using the Vortech retainer and washer. The retainer should go through the cable end, washer, return-spring bracket and into the arm.

*** NOTE ***

There is a plastic sheath that normally protects the cable. Remove this as it may hang-up on the end of the cable housing.

- G. Install the throttle return spring.

- H. Check for full throttle by pressing the accelerator to the floor and verifying that the carburetor butterflies open fully.
- I. If possible, pressurize the fuel system and check for leaks.
- J. Using the supplied 5/16" cap screws, install the top cover on the enclosure and tighten the screws.
- K. Use the supplied hardware to plug any open holes in the carburetor enclosure and cover.

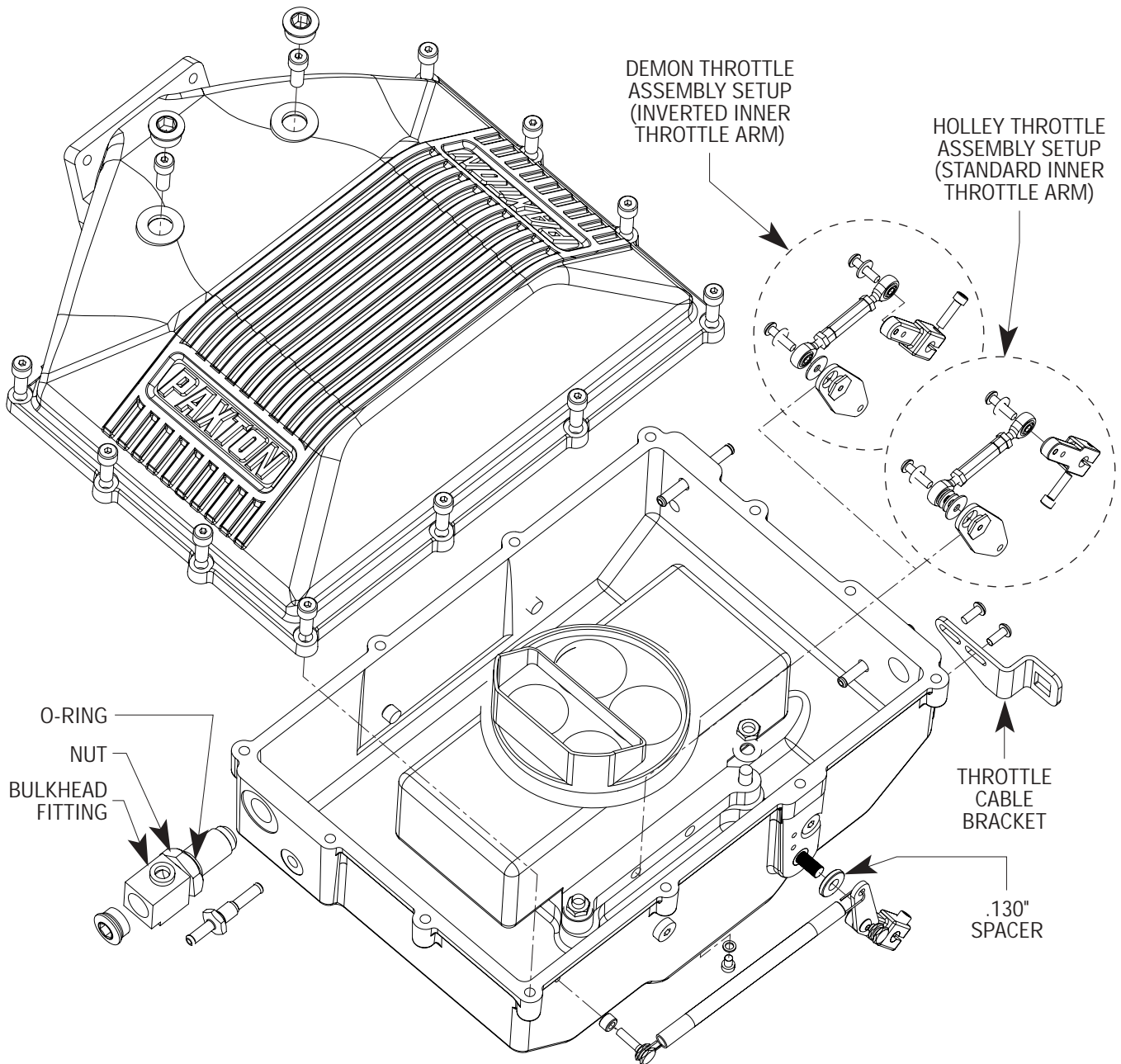

Fig. 5-h

Section 6

AIR INLET INSTALLATION

6.1 AIR INLET INSTALLATION (on the passenger's side)

- A. Install the supplied 3.5" steel flanged bulk-head in the hole where the factory plastic inlet duct was removed. Use the bulkhead as a template mark and drill the four mounting holes using an 1/8" drill. Attach the bulk-head using the supplied self-tapping screws. (See Fig. 6-a.)



Fig. 6-a

- B. Unscrew and pull back the passenger side plastic inner fender to gain access to the filter location. Attach the 3.5" plastic 90° tube to the bulkhead using the supplied 3.5" x 2" sleeve and #56 hose clamps. Attach the air filter to the tube and rotate assembly for best inner fender clearance. (See Fig. 6-b.)



Fig. 6-b

- C. Re-install the plastic inner fender.
- D. Install the 1/4"NPT-5/8" barb 90° and the 1/4"NPT-3/8" barb 90° into the 4" x 3.5" cast elbow. (See Fig. 6-d.)

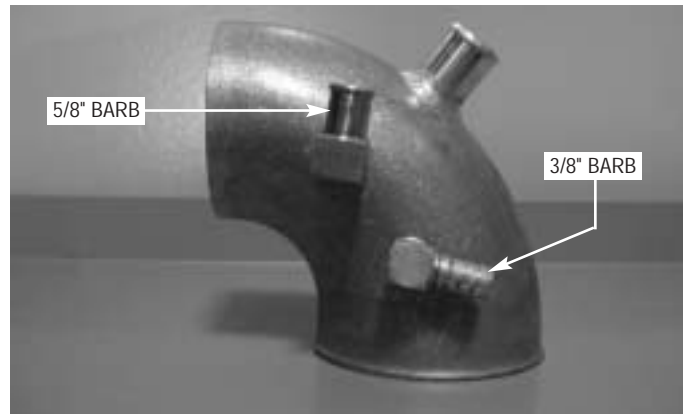

Fig. 6-d

- E. Using the supplied #64 hose clamps, attach the 4"ID x 2" long sleeve and 4" x 3.5" cast elbow to the supercharger inlet. (See Fig. 6-e.)



Fig. 6-e

- F. Using the #52 hose clamps connect the section of 3.5" flex-hose between the cast elbow and the 3.5" steel flange bulkhead. (See Fig. 6-e.)

- G.** Connect the supplied length of 5/8" hose to the previously installed 5/8" 90° fitting on the cast elbow. Trim for best fit and attach to the stock fitting on the valve cover. (See Fig. 6-g.)



Fig. 6-g

- J.** Connect a piece of the supplied vacuum line to the top of the by-pass valve. Route the line to the rear of the carburetor enclosure and attach to the vacuum fitting previously installed.

- H.** Connect the factory 3/8" hose with the check valve (previously connected to factory carburetor) to the 3/8" 90° fitting installed in the cast inlet elbow. Route the A/C line down under the 1" port on the cast inlet elbow. (See Fig. 6-h.)
- I.** Attach a piece of the supplied 1"ID rubber hose approximately 9.5" long to the 1" port on the cast elbow and secure using a #16 hose clamp. Connect the by-pass valve to the open end of hose and secure with a #16 hose clamp. Attach a piece of 1"ID rubber hose approximately 2" long to the open end of the by-pass valve and secure using a #16 hose clamp. (See Fig. 6-h.)

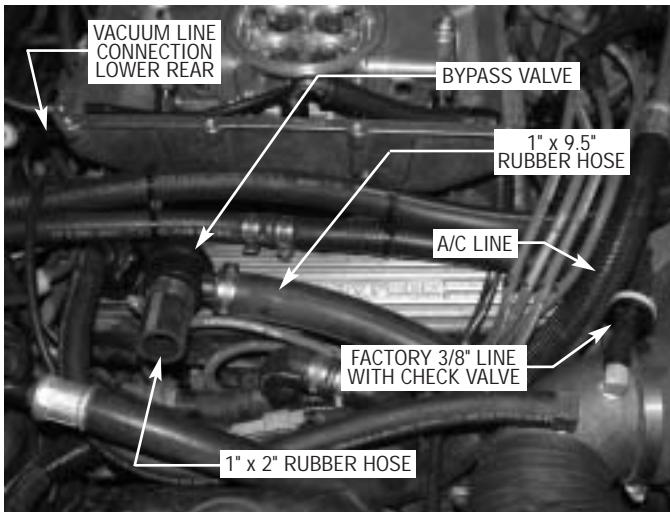

Fig. 6-h

Section 7

SUPERCHARGER DISCHARGE

7.1 SUPERCHARGER DISCHARGE

- A. Attach the 3" x 3" sleeve onto the supercharger discharge using the supplied #44 hose clamp. (See Fig. 7-a.)

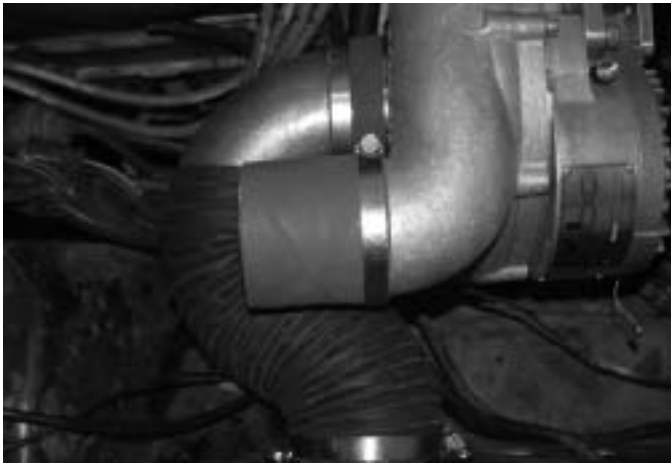

Fig. 7-a

- B. Install the 3/4"NPT x 1" plastic 90° into the cast discharge tube as seen. (See Fig. 7-b.)



Fig. 7-b

- C. Using the supplied 5/16-18 x 3/4" socket head screws and gasket, attach the 3.5" cast flange onto the carburetor enclosure lid. (See Fig. 7-c.)



Fig. 7-c

- D. Using the supplied #52 hose clamp, secure the 3.5" x 3" reducer sleeve to the 3.5" cast flange. (See Fig. 7-d.)



Fig. 7-d

Install the discharge tube between the super-charger discharge and carburetor enclosure inlet and secure with the remaining #44 hose clamps. Attach the by-pass valve to the 1" x 90° fitting on the discharge tube and secure with a #16 hose clamp. (See Fig. 7-e.)

***** NOTE *****

Check that all clamps are tight.



Fig. 7-e

Section 8

FINAL CHECK OUT AND START UP

This section covers pre-start checks and inspections, as well as initial start-up.

8.1 Inspect the following:

- A. Wires, harnesses and electrical connections. Are all items properly dressed, connected and secured? If any electrical connections have been dis-connected, re-connect them before you start your vehicle.
- B. Hoses, lines and fittings. Are all items properly dressed, connected and secured?
- C. Fasteners, brackets, and clamps. Are all items properly installed and tightened?
- D. Fluid levels. Is the radiator coolant and the engine oil at their proper levels? Are there any fluid leaks?
- C. Belt(s). Is the serpentine drive belt (or accessory drive and supercharger drive belts, depending on the requirement of your vehicle) properly installed, aligned and tensioned?

8.2 Perform the following:

- A. Re-jet the carburetor as required. Check the ignition timing to make sure that it is properly set.

***** NOTE *****

*This manual does not address specific settings for air/fuel timing requirements. Engine tuning **MUST** be performed by an experienced technician or serious engine damage may result.*

- B. Check the entire fuel system for any leaks.
- C. Start the car. Verify that the oil pressure is within the normal operating range. Listen closely. The engine should idle and sound the same as it did before you began the installation. Shutdown the engine, disconnect the oil feed line from the blower. Remove the oil jet from the blower. Blow through the oil jet to ensure there is no blockage or foreign matter plugging it. Re-install oil jet and oil feed line and proceed.
- D. Allow the engine to come to normal operating temperatures. Bleed the cooling system and top off as necessary.

8.3 Check for the following:

- A. Fuel leaks.
- B. Fluid leaks.
- C. Belt slippage.
- D. Throttle response.

*****CAUTION*****

See the supercharger service manual included in your kit for information on supercharger servicing and maintenance, belt tightening, troubleshooting, special tuning, and warranty information.

Now that the work is done, it's time to enjoy your labor of love. Take the car out on the road and let it flex it's muscles, but remember, the response and performance will now be different from that to which you have been accustomed. Have fun!

***** IMPORTANT NOTE *****

Due to tight tolerances , be very careful when closing the hood for the first time, making sure that there is not any interference between the s/c and the hood of the car. By doing this you will eliminate damaging your vehicle and/or supercharger.



Completed Installation on a Carbureted 5.0L Ford Mustang Motor

Appendix

Please realize that PAXTON Automotive is constantly improving the performance and look of the NOVI 2000 supercharger. Parts in your kit may appear differently than what is pictured in this manual. This is due to photographs taken in pre-production, a change in material costs, or an improvement in performance.

Rest assured that you have purchased to best quality kit that PAXTON Automotive manufactures at this time. The installation of the materials will remain the same.

Appendix	Part Number	Description	Page
A	1016611	Asy, Mtg Brkt 5.0L Novi 2000	A-2
B	1016710	Asy, Crank Pulley, 86-93 5.0L Novi 2000	A-3

P/N: 4PFX020-020
 ©2006 Paxton Automotive
 All Rights Reserved, Intl. Copr. Secured
 24APR06 v1.1 MusGT(4PFX..020 v1.1)

A-2

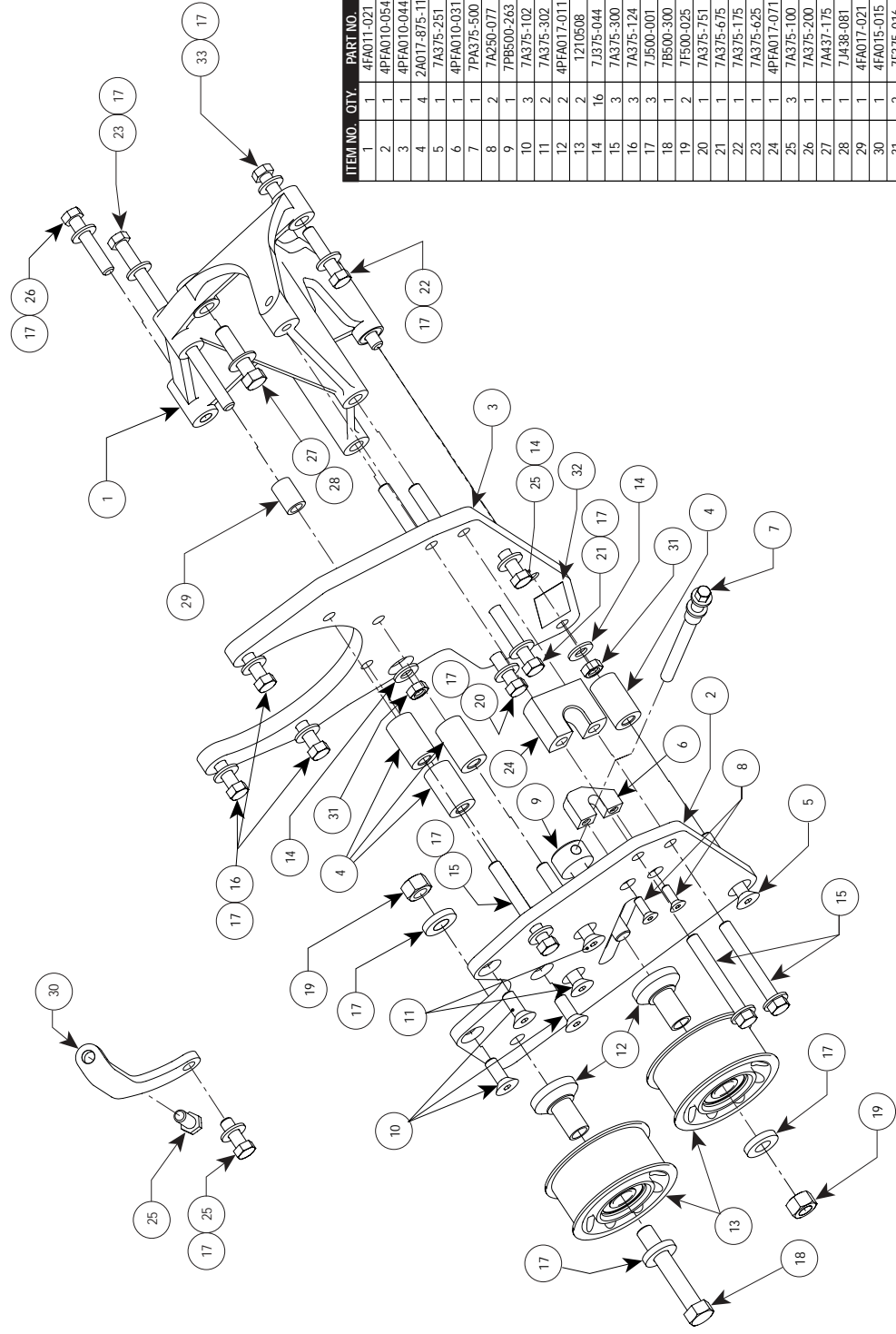

ITEM NO.	QTY.	PART NO.	DESCRIPTION
1	1	4FA011-021	MING BRCKT, S/C
2	1	4PFA010-054	PLATE, FRONT
3	1	4PFA010-044	PLATE, REAR
4	4	2A017-875-11	SPACER, 8.75" x 1.482L
5	1	7A375-251	3/8-16 x 2 1/2" FL SHCS
6	1	4PFA010-031	IDLR SCREW
7	1	7PA375-500	SCREW, IDLR ADJR
8	2	7A250-077	5/16-18 x 3/8" HHCS-SS
9	1	7PB500-263	ARBOR, SC TENS PLY
10	3	7A375-102	3/8-16 x 1.0" FL SHCS
11	2	7A375-302	3/8-16 x 3.0" FHD
12	2	4PFA017-011	COLLAR, 10-RIB PLY, NOV1
13	2	1210508	PULLEY, IDLR SMOOTH
14	16	71375-044	WASHER, 3/8"SAE PLTD
15	3	7A375-300	3/8-16 x 3" HHCS
16	3	7A375-124	3/8-16 x 1-1/4" HHKD
17	3	7J500-001	WASHER, 1/2"ID x 1.12"OD
18	1	7B500-300	1/2-20 x 3" HHKD
19	2	7F500-025	1/2-20 x 1.5" HHCS
20	1	7A375-751	3/8-16 x 7" HHKD
21	1	7A375-675	3/8-16 x 6.75" HHKD
22	1	7A375-175	3/8-16 x 1.75" HHKD
23	1	7A375-625	SCREW, HHKD 3/8-16UNC-2A x 6.25"LG
24	1	4PFA017-071	SPACER, ALT BRCKT
25	3	7A375-100	3/8-16 x 1" HHKD
26	1	7A375-200	3/8-16 x 2" HHKD
27	1	7A437-175	7/16-14 x 1.75" HHKD
28	1	71A38-081	7/16"SAE WASHER
29	1	4FA017-021	SPACER, SMOG
30	1	4FA015-015	ALTERNATOR STAY
31	2	7F375-016	3/8-16 FX NUT
32	1	4832500	LABEL, ALTERNATOR DATA
33	1	7A375-650	3/8-16 x 6.50" HHKD

UNLESS OTHERWISE SPECIFIED
 DIMENSIONS ARE IN INCHES
 TOLERANCES ARE: XX: .01
 DECIMALS: .XXX: .005
 FRACTIONS: ±1/2"
 ANGLES: ±1/16"

MATERIAL SEE PARTS LIST

FINISH NONE

CAD GENERATED DRAWING,
 DO NOT MANUALLY UPDATE

APPROVALS: DATE 01/27/03

DRAWN: TAP

ENGINEERING: R&D

APPR: WEIGHT

86-93 MUSTANG 5.0L w/NOV1 2000

ASY, S/C MING BRKT

SCALE: 1:1.5

DO NOT SCALE DRAWING

SHEET 1 OF 1

A. Part Number: 1016611 Asy, Mounting Bracket 5.0 Novi 2000

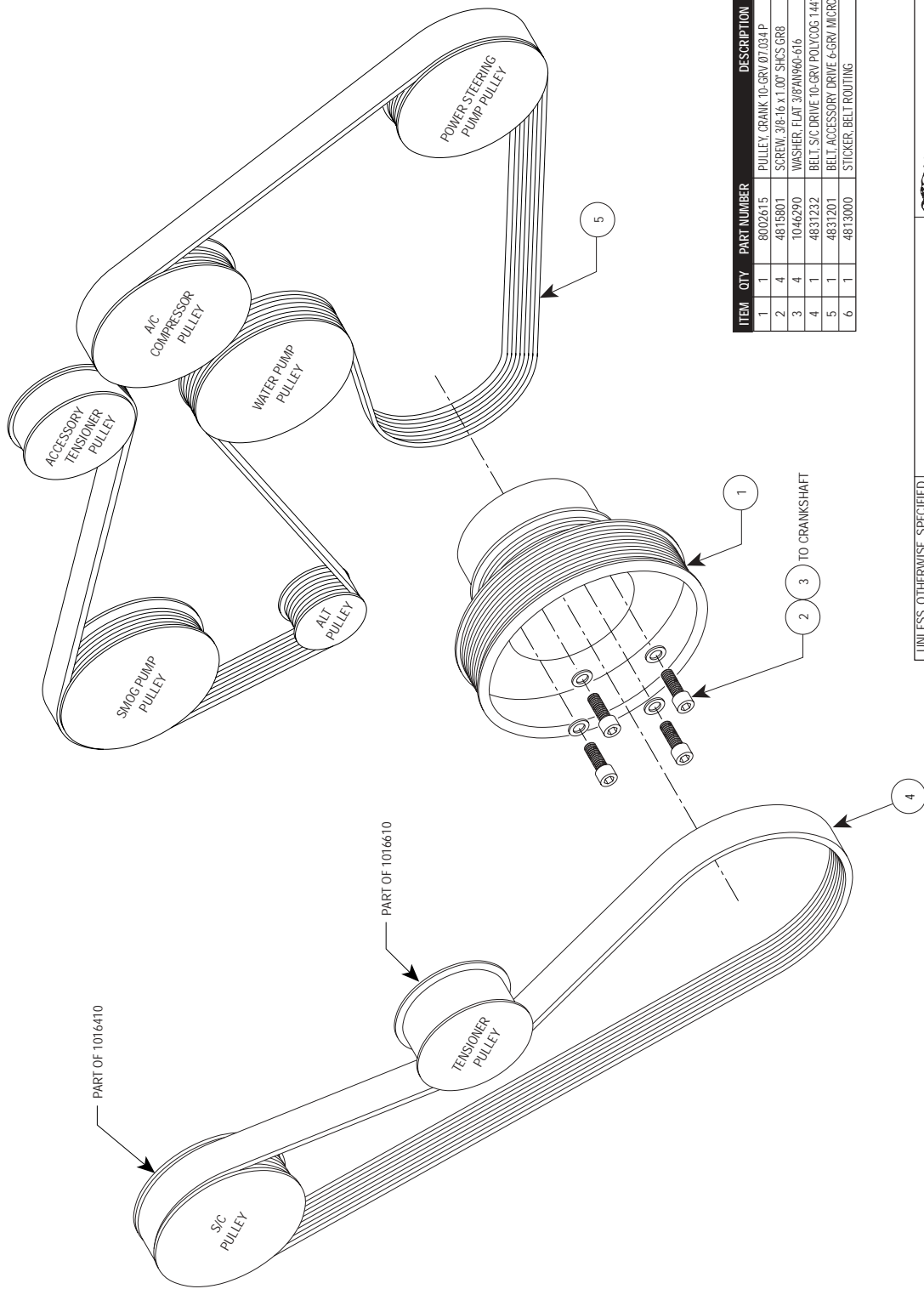

ITEM	QTY	PART NUMBER	DESCRIPTION
1	1	8002615	PULLEY, CRANK 1D-GRV/07.034.P
2	4	4815801	SCREW, 3/8-16 x 1.00" SHCS GR8
3	4	1046290	WASHER, FLAT 3/64x1/64-616
4	1	4831232	BELT, S/C DRIVE 1D-GRV POLYCOG 1441mm x 35.7mm
5	1	4831201	BELT, ACCESSORY DRIVE 6-GRV MICRO-V 2525mm x 21mm
6	1	4813000	STICKER, BELT ROUTING

UNLESS OTHERWISE SPECIFIED
DIMENSIONS ARE IN INCHES
TOLERANCES ARE: XX.XX .01
DECIMALS: XXX.XX .005
FRACTIONS: ±1/2
ANGLES: ±1/16

CAD GENERATED DRAWING,
DO NOT MANUALLY UPDATE

APPROVALS

DRAWN: CFB DATE: 8/14/01

ENGINEERING: R&D

APPR: NONE WEIGHT: --- LBS

FINISH: NONE

SEE PARTS LIST

MATERIAL: 86-93 MUSTANG 5.0L WINDUFI

ASX CRANK PULLEY

SIZE: C DWG. NO. 1016710

SCALE: NONE DO NOT SCALE DRAWING

REV. F

SHEET 1 OF 1

1300 BEACON PLACE OXNARD, CA 93033
TEL: (805) 604-1336 FAX: (805) 604-1337



B. Part Number: 1016710

Asy, Crank Pulley 86-93 5.0 Novi 2000



*Paxton Automotive . 1300 Beacon Place . Oxnard CA 93033
805 604-1336 . FAX (805) 604-1337*